



**EMERGÈNCIA  
CLIMÀTICA**  
*fets i dades*

**DOCUMENT TÈCNIC**



**GENERALITAT  
VALENCIANA**

Conselleria d'Agricultura,  
Desenvolupament Rural,  
Emergència Climàtica  
i Transició Ecològica



**CENTRE D'EDUCACIÓ  
AMBIENTAL**

DE LA COMUNITAT VALENCIANA







## Exposició



## Exposició



## Elements expositius

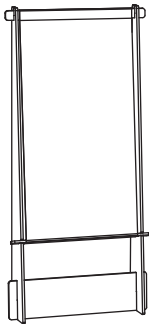

**17 ESTRUCTURES «A»**  
17 panells de continguts

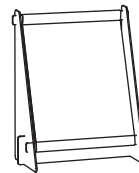

**4 ESTRUCTURES «B»**  
4 blocs temàtics

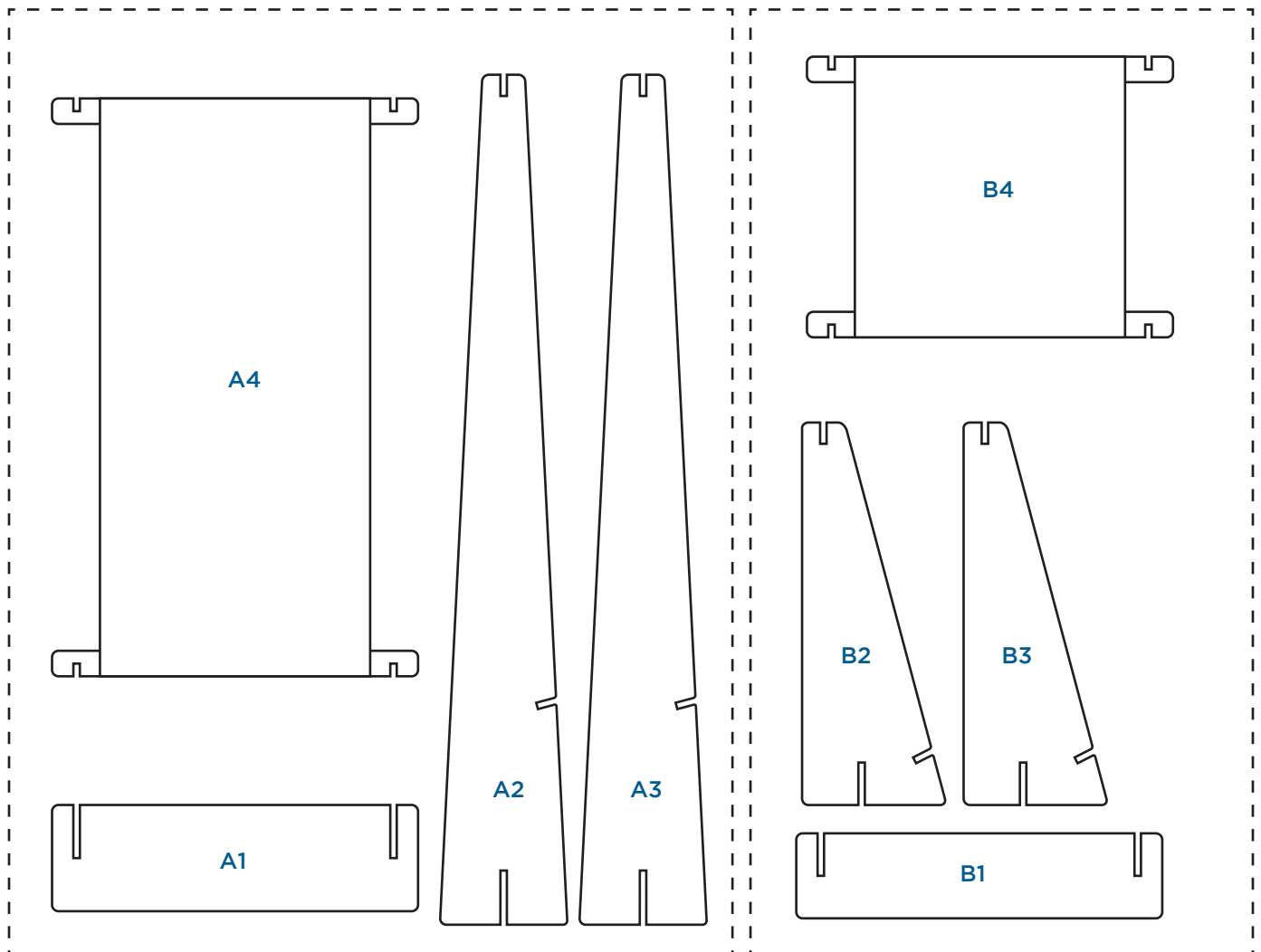

**PECES ESTRUCTURA «A»**

**PECES ESTRUCTURA «B»**



# INSTRUCCIONS DE MUNTATGE

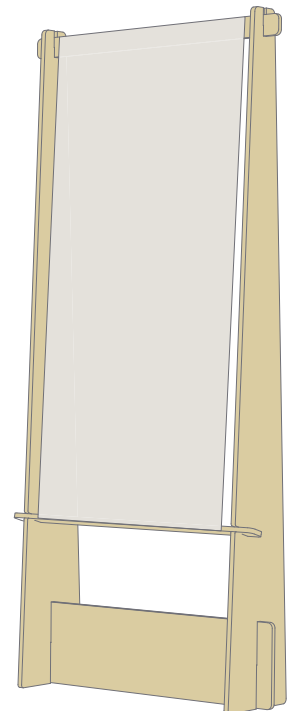
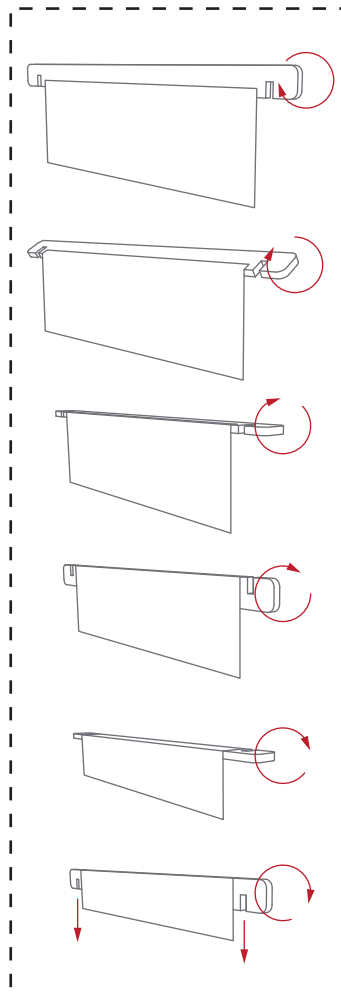
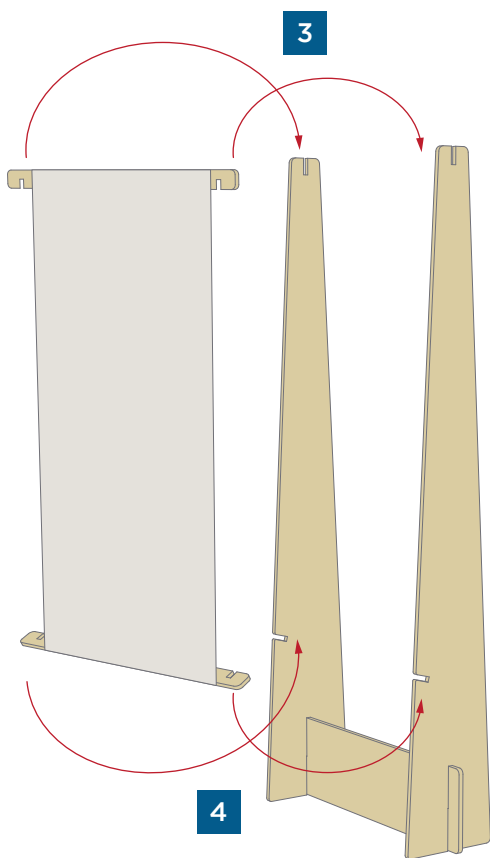
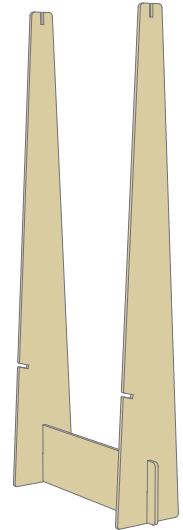
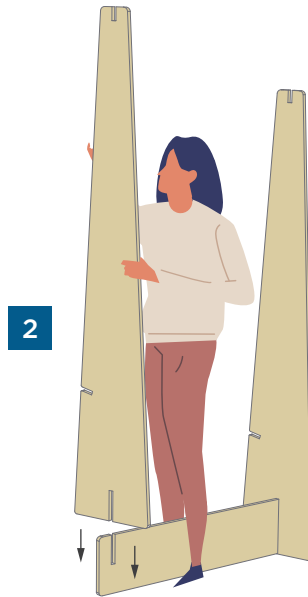
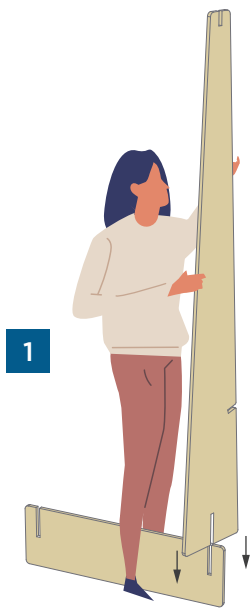

## Embalatge

