



**EMERGÈNCIA  
CLIMÀTICA**  
*fets i dades*

**DOCUMENTO TÉCNICO**



**GENERALITAT  
VALENCIANA**

Conselleria d'Agricultura,  
Desenvolupament Rural,  
Emergència Climàtica  
i Transició Ecològica



**CENTRE D'EDUCACIÓ  
AMBIENTAL**

DE LA COMUNITAT VALENCIANA

## Exposició itinerante para préstamo

### RESOLUCIÓN DE ESTRUCTURAS Y ELEMENTOS EXPOSITIVOS

#### MATERIALES

##### SOPORTES EXPOSITIVOS

Tablero de madera de pino 15 mm espesor. Certificación FSC.

##### ELEMENTOS IMPRESOS

Impresión directa sobre lona 100% fibras de algodón.

Certificación de Origen de algodón: España.



#### ESTRUCTURAS

Estructuras auto-encajables sin tornillería.

Fácil manipulación.



## Exposició



## Exposició



## Exposició



## Elementos expositivos

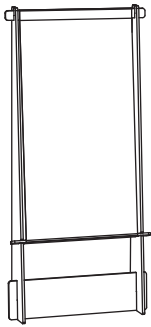

**17 ESTRUCTURAS «A»**  
17 paneles de contenidos

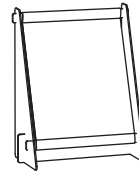

**4 ESTRUCTURAS «B»**  
4 bloques temáticos

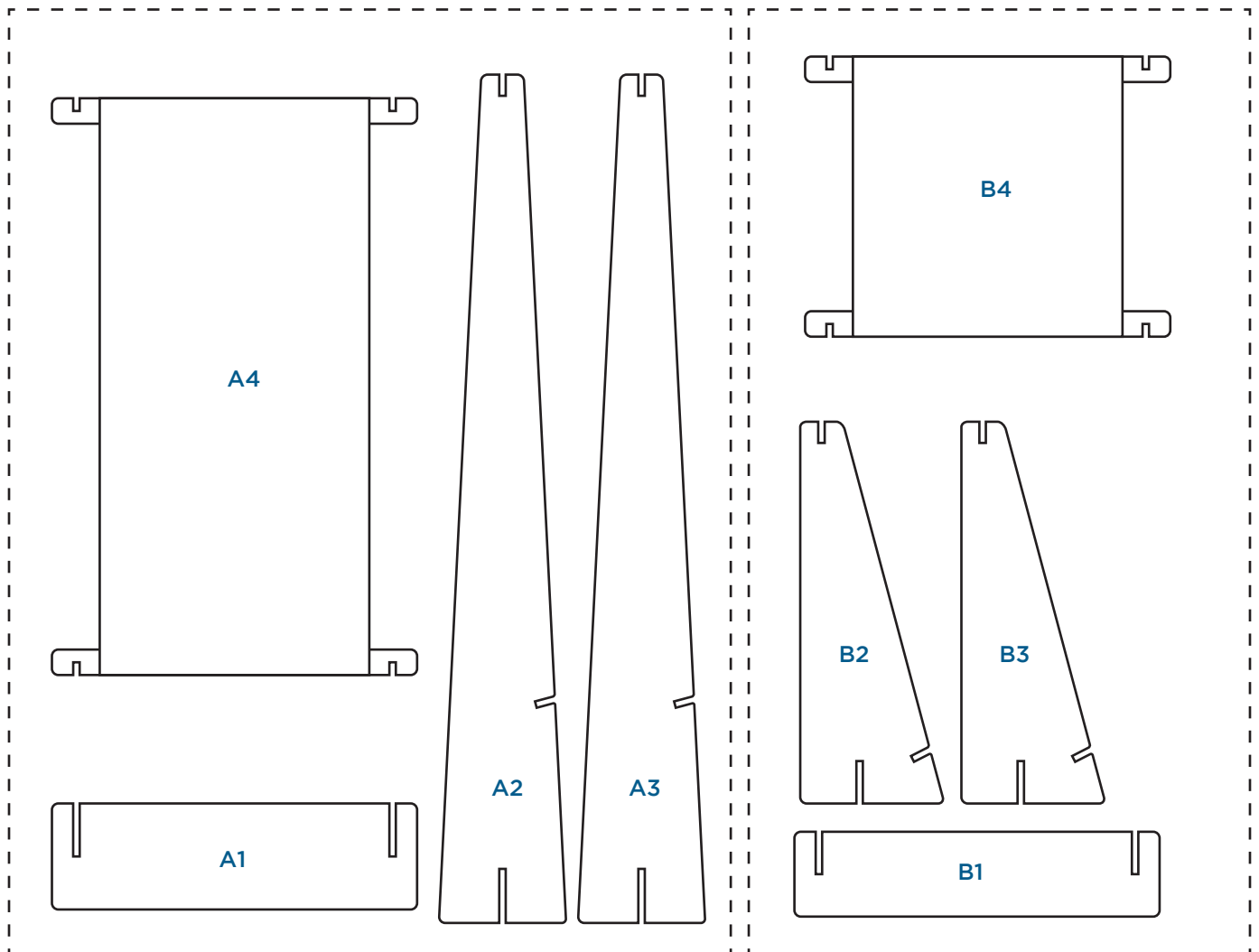

**DESPIECE ESTRUCTURA «A»**

**DESPIECE ESTRUCTURA «B»**

# INSTRUCCIONES DE MONTAJE

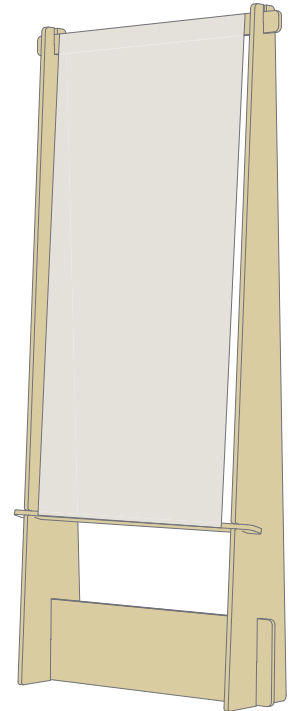
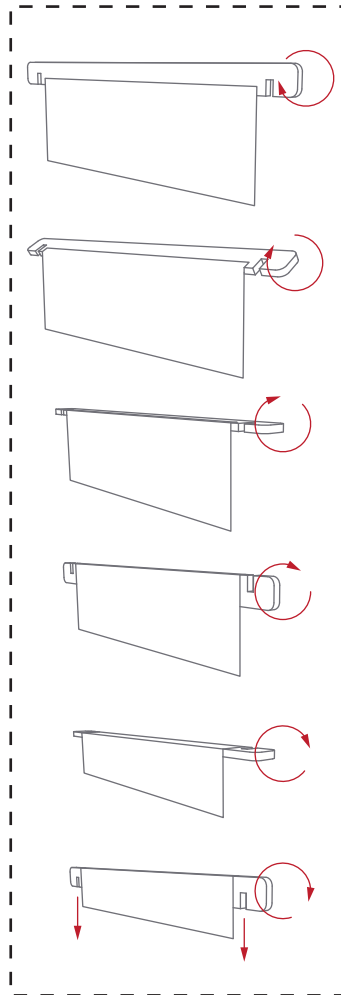
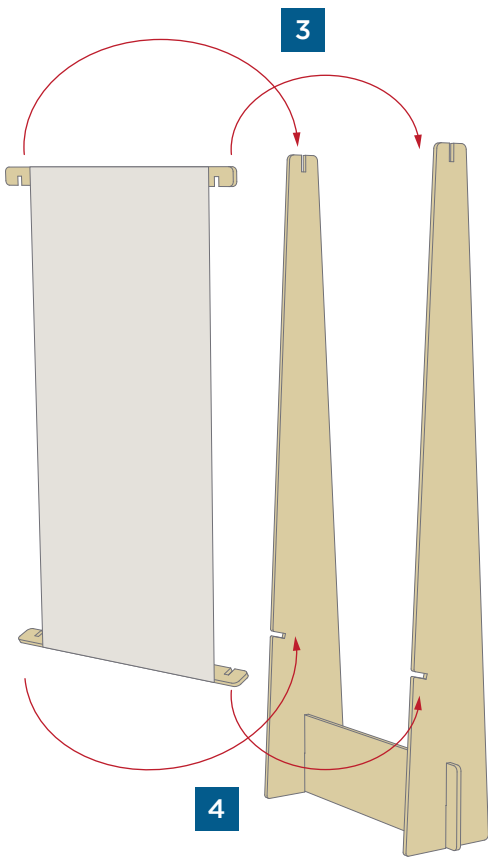
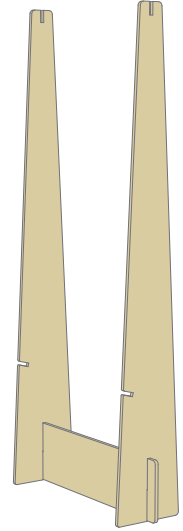
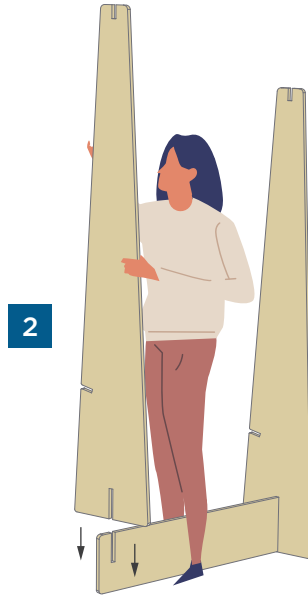
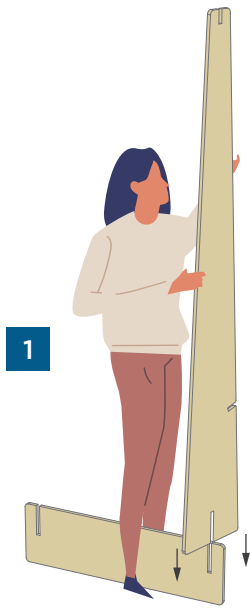

## Embalaje

